



US00D517581S

(12) **United States Design Patent** (10) **Patent No.:** **US D517,581 S**
Apothéloz et al. (45) **Date of Patent:** **** Mar. 21, 2006**

(54) **MICROSCOPE TUBE**
(75) Inventors: **Christophe Apothéloz**, Zurich (CH);
Manfred Gilbert, Schoeffengrund (DE); **Russell Bonaventura**,
Williamsville, NY (US)

D420,028 S * 2/2000 Wani et al. D16/131
D439,258 S * 3/2001 Kawahata D16/131
D440,996 S * 4/2001 Takanashi D16/131
6,479,807 B1 * 11/2002 Toshimitsu 250/201.3
6,512,632 B1 * 1/2003 Yamamoto 359/383
D502,194 S * 2/2005 Suzuki et al. D16/131

* cited by examiner

(73) Assignee: **Leica Microsystems Wetzlar GmbH**,
Wetzlar (DE)

Primary Examiner—Paula A. Greene

(**) Term: **14 Years**

(74) *Attorney, Agent, or Firm*—Simpson & Simpson, PLLC

(21) Appl. No.: **29/213,060**

(57) **CLAIM**

(22) Filed: **Sep. 13, 2004**

The ornamental design for a microscope tube, as shown and described.

(30) **Foreign Application Priority Data**

DESCRIPTION

Mar. 13, 2004 (DE) 4 04 01 681

FIG. 1 is a front perspective view of a microscope tube of our invention;

(51) **LOC (8) Cl.** **16-06**

FIG. 2 is a left side view of the microscope tube of our invention;

(52) **U.S. Cl.** **D16/131**

FIG. 3 is a front view of the microscope tube of our invention;

(58) **Field of Classification Search** D16/130,
D16/131, 134; 359/381, 382, 383, 384, 385,
359/388, 375, 376, 377, 379, 378, 390, 392,
359/393; 250/201.3

FIG. 4 is a right side view of the microscope tube of our invention.

See application file for complete search history.

FIG. 5 is a rear view of the microscope tube of our invention.

(56) **References Cited**

U.S. PATENT DOCUMENTS

3,064,529 A * 11/1962 Straat 359/384
D273,592 S * 4/1984 Armbruster D16/131
D355,430 S * 2/1995 Hofmann-Igl D16/131
D400,548 S * 11/1998 Komatsuzaki D16/131
D417,880 S * 12/1999 Wani et al. D16/131

FIG. 6 is a top view of the microscope tube of our invention.

FIG. 7 is a bottom view of the microscope tube of our invention; and,

FIG. 8 is a front perspective view of a microscope tube of our invention; the broken line showing of a microscope stand and microscope eyepiece are for illustrative purposes only and form no part of the claimed design.

1 Claim, 8 Drawing Sheets

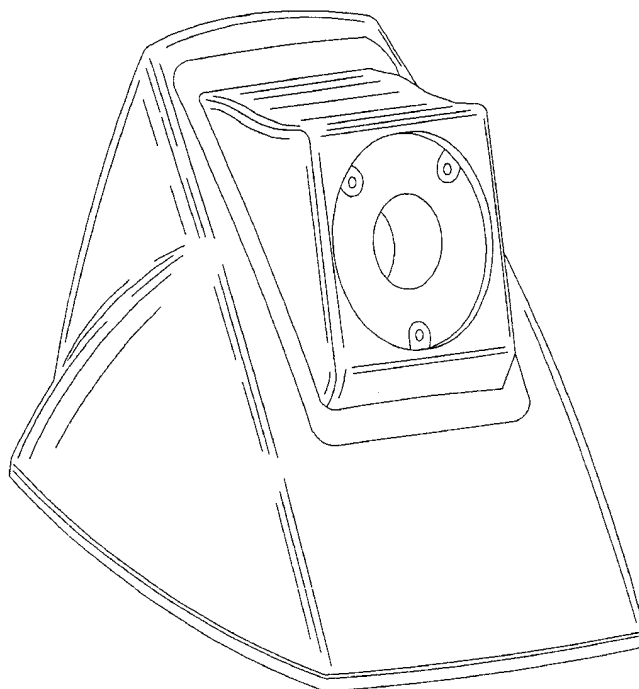

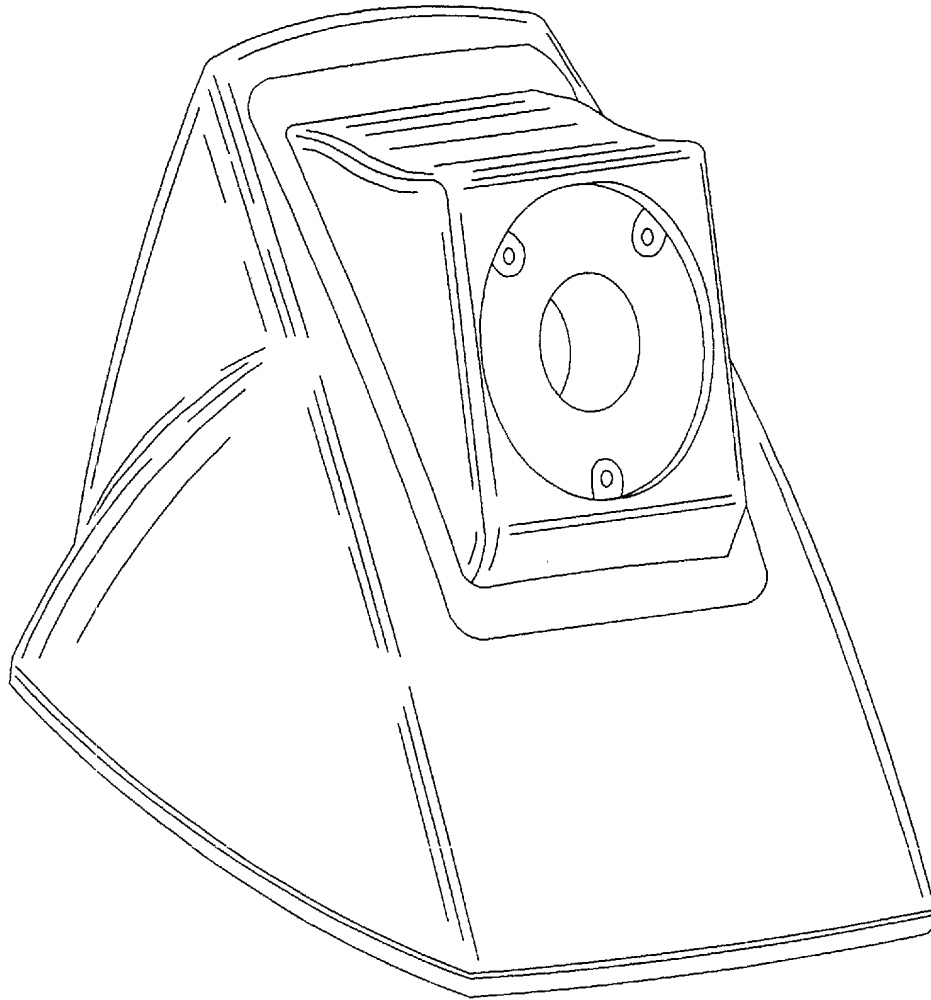

Fig. 1

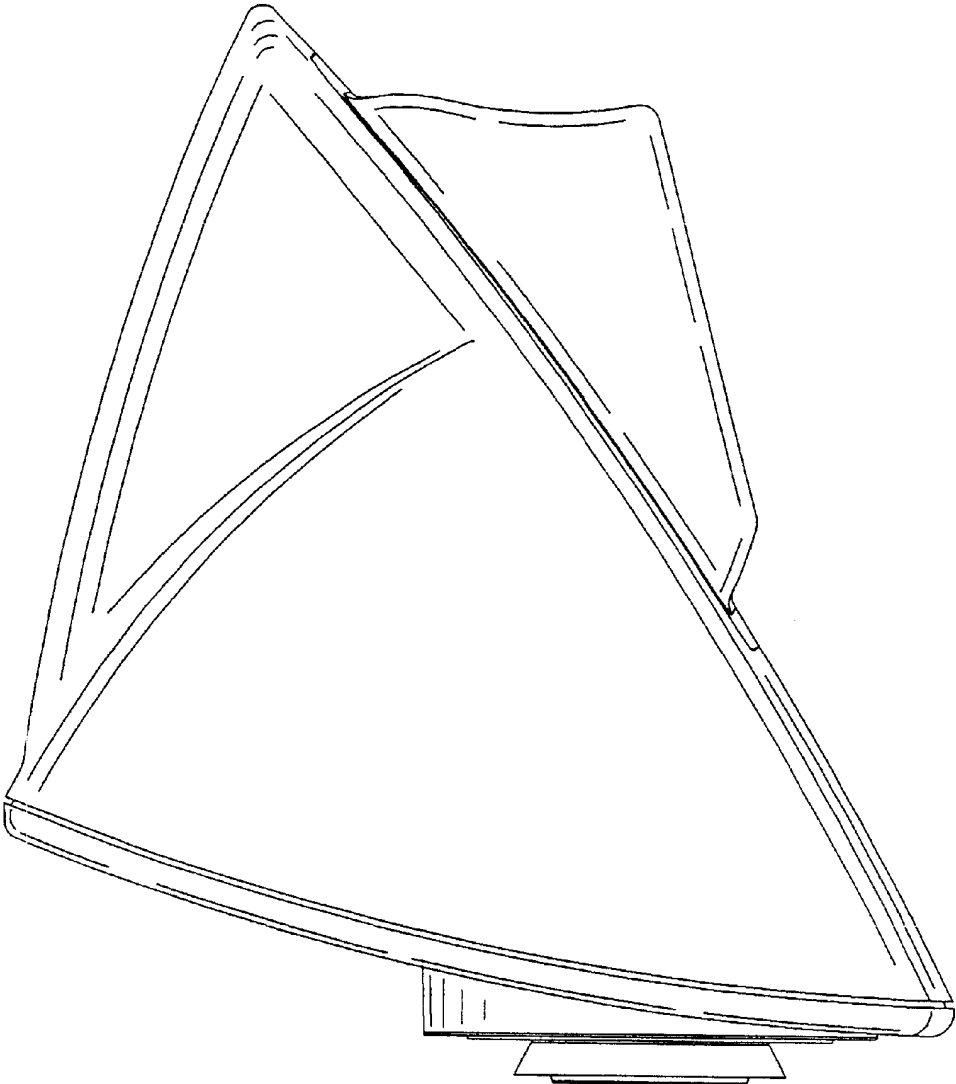

Fig. 2

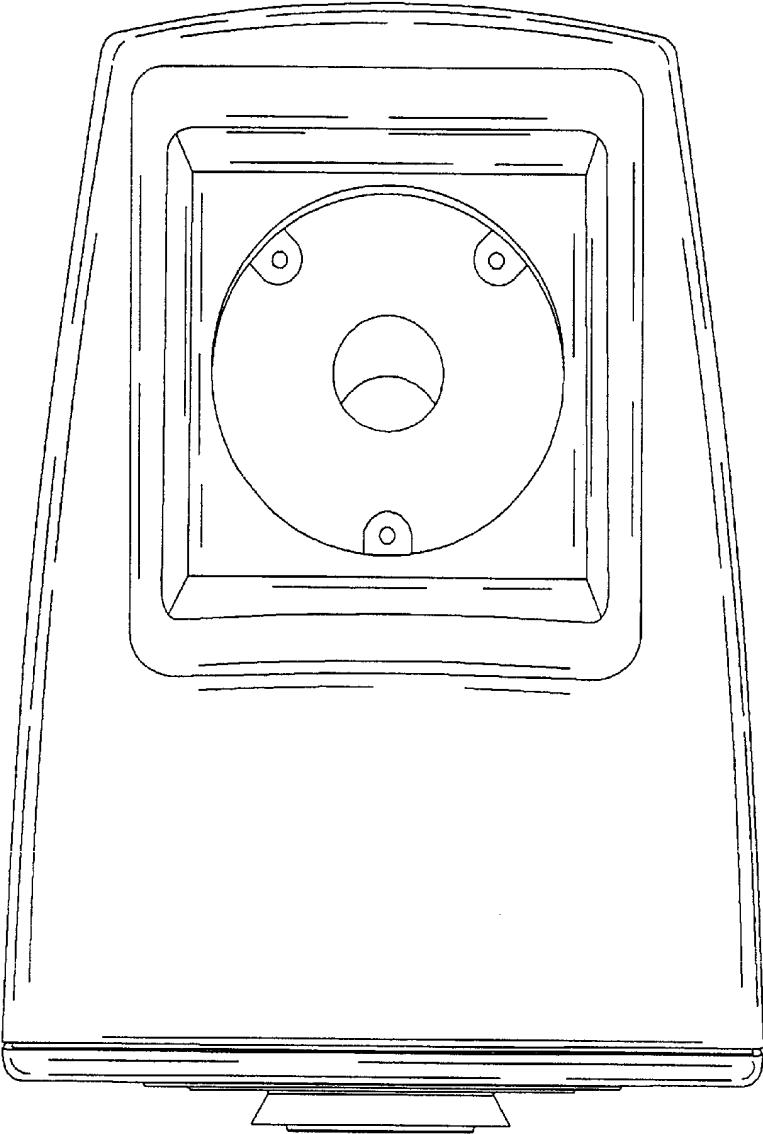

Fig. 3

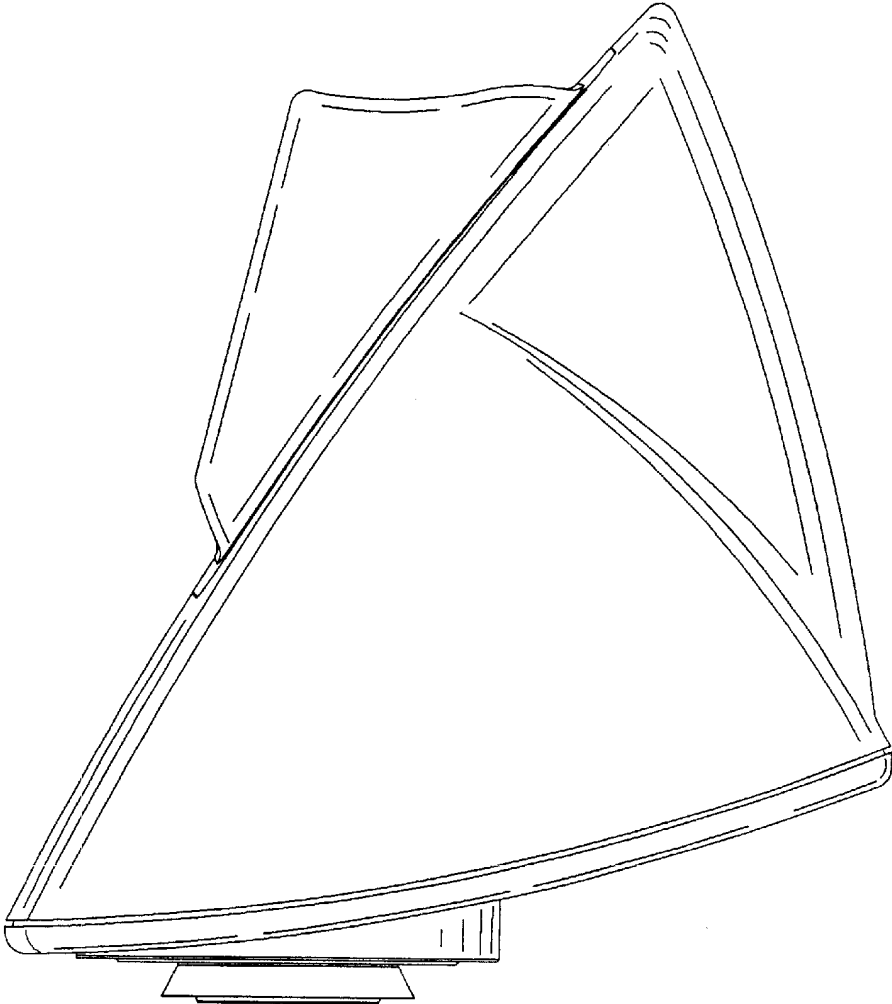

Fig. 4

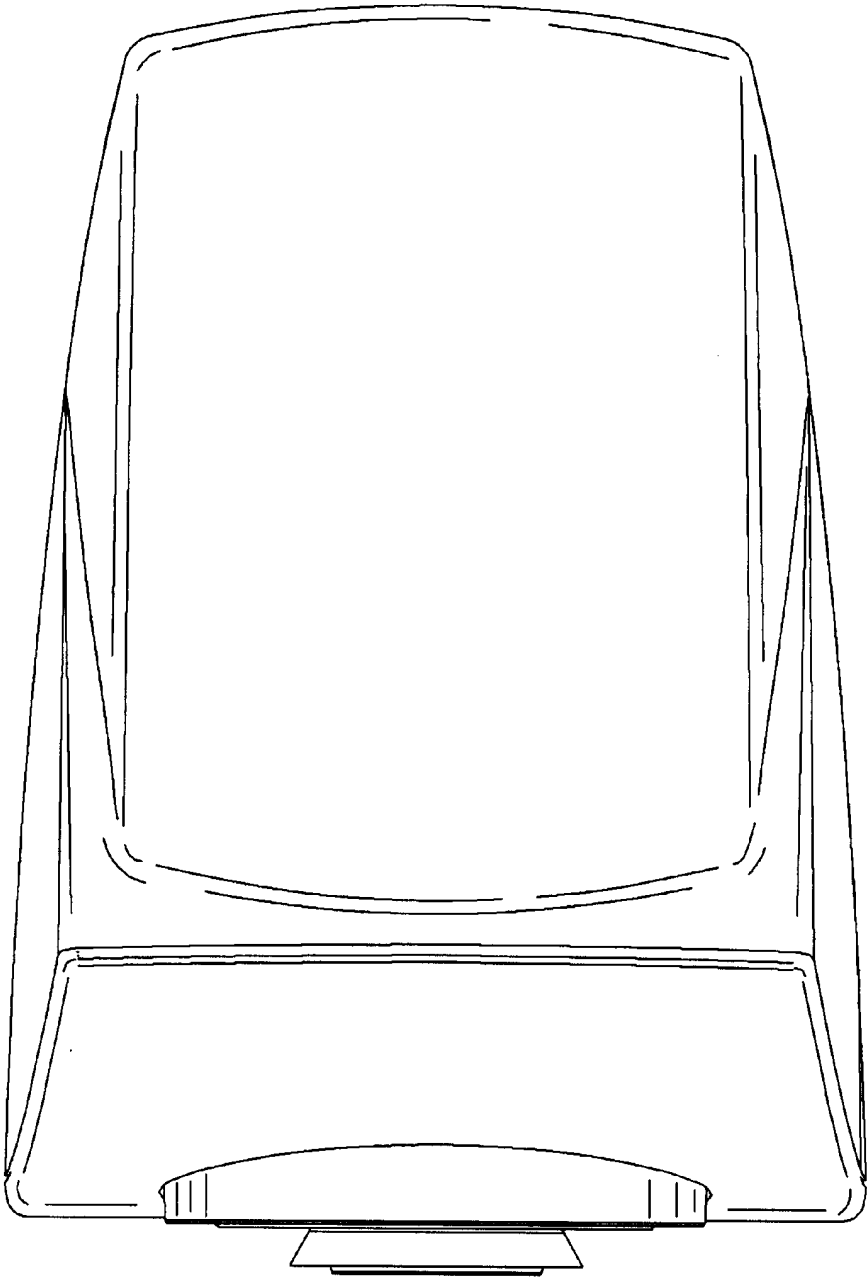

Fig. 5

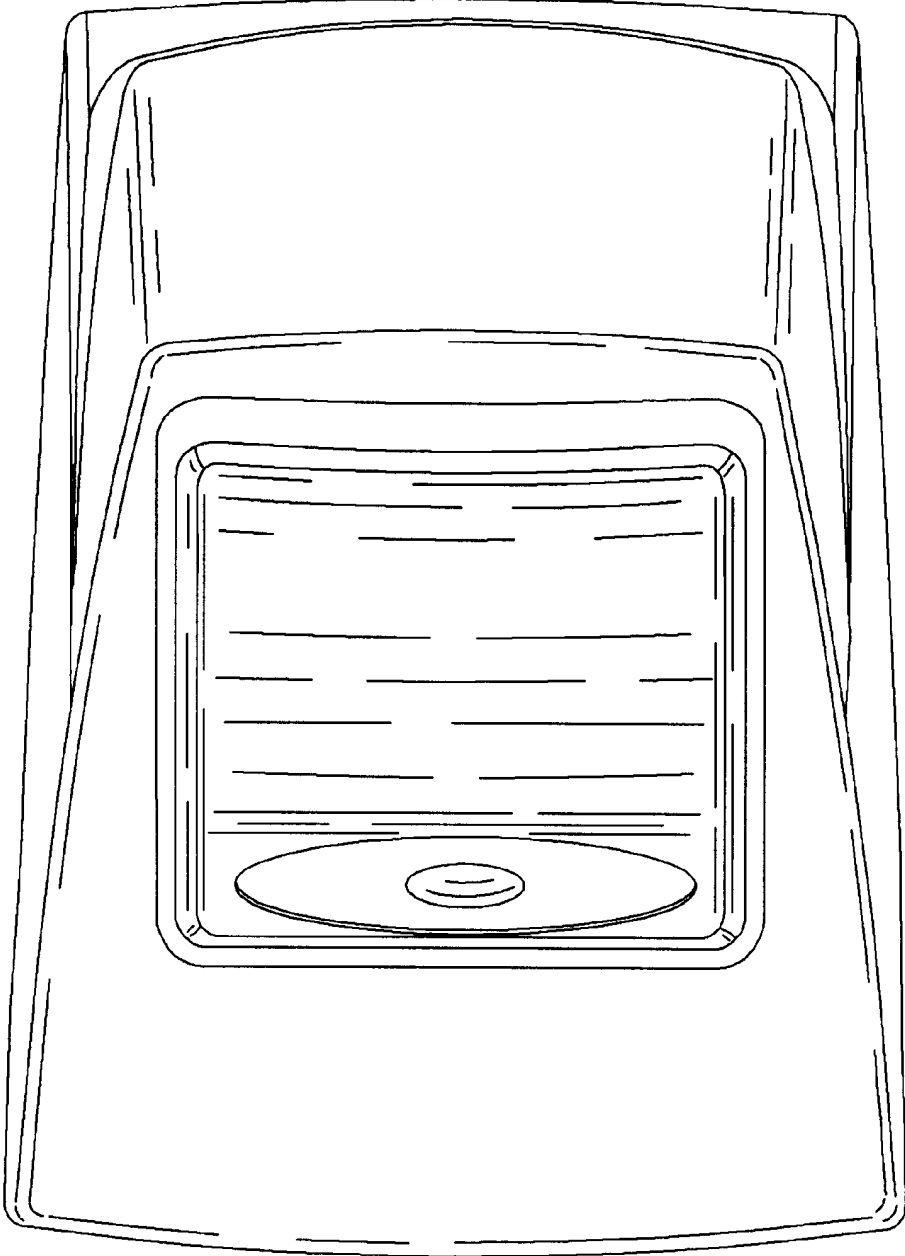

Fig. 6

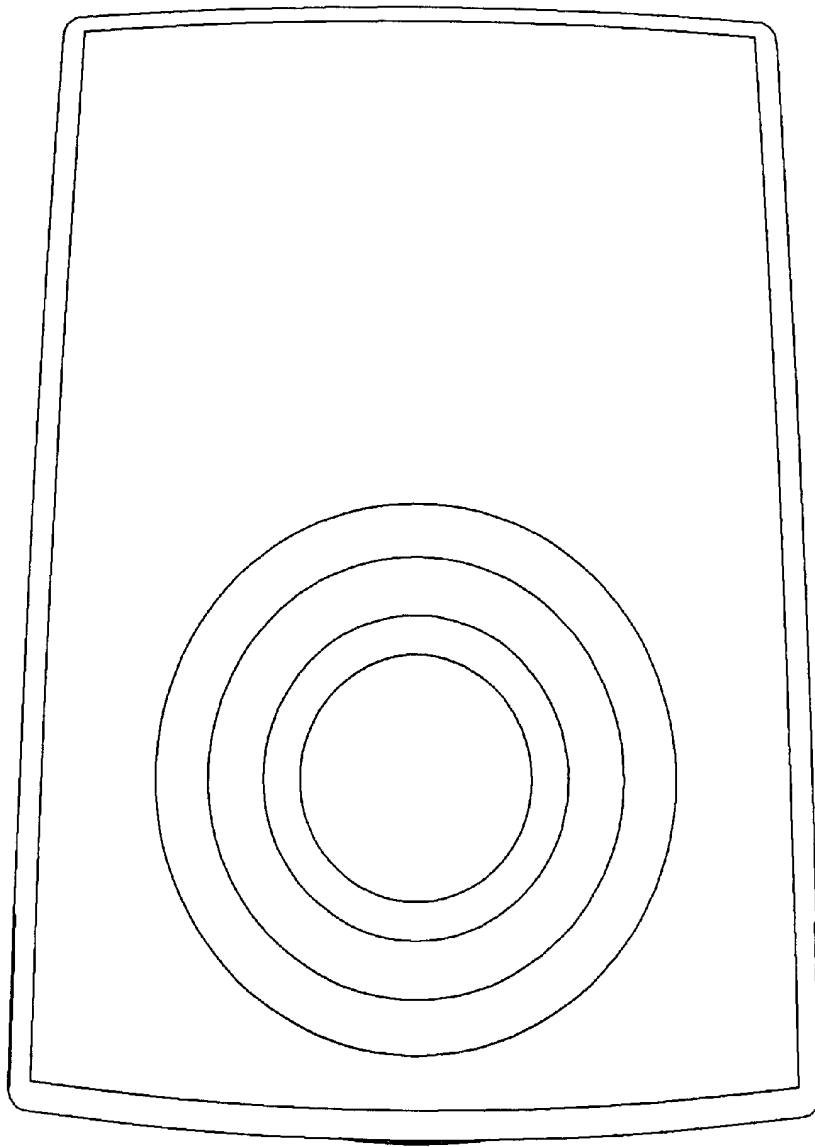

Fig. 7

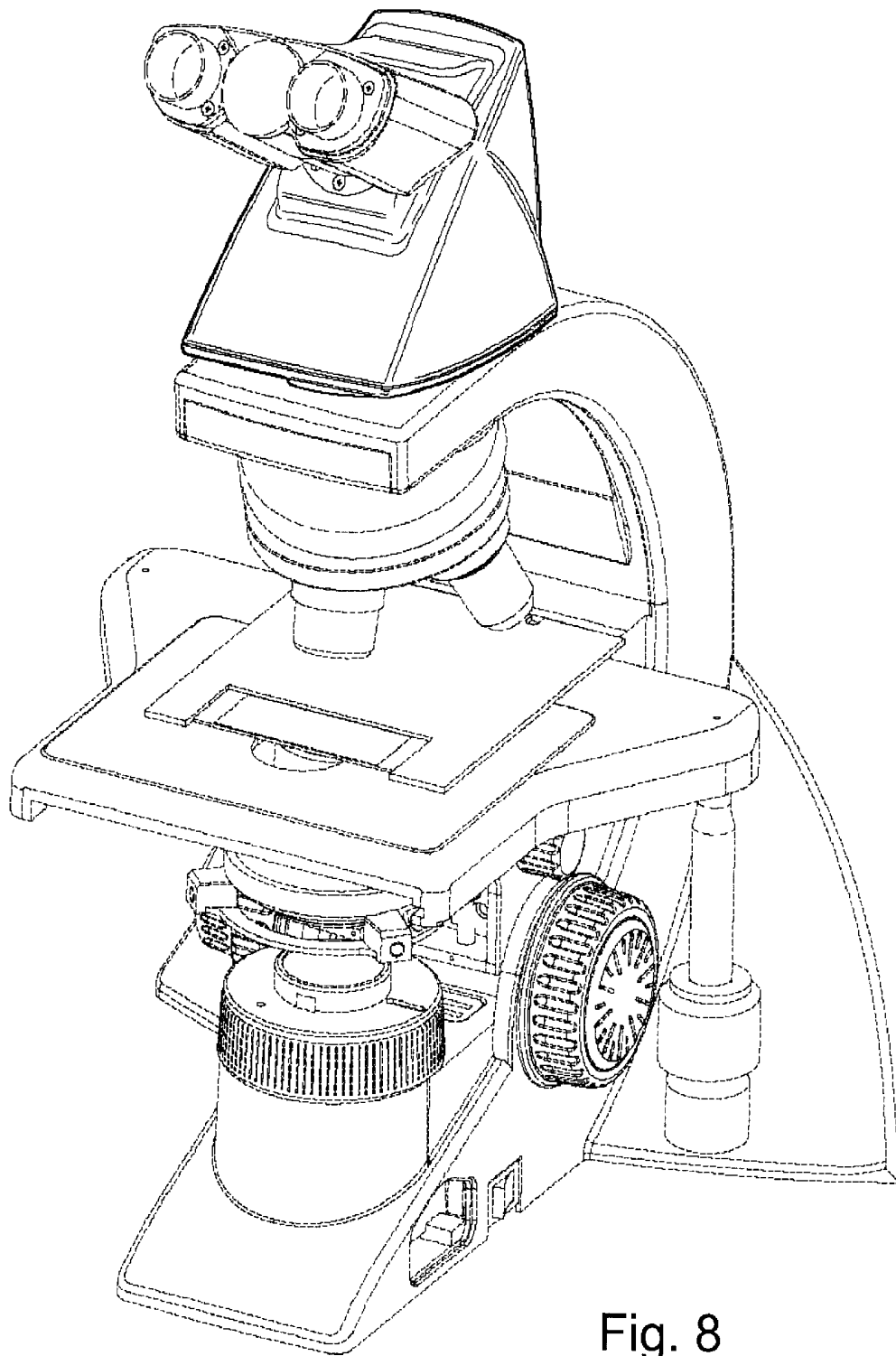

Fig. 8