



US00D946304S

(12) **United States Design Patent**
Asis

(10) **Patent No.:** **US D946,304 S**

(45) **Date of Patent:** **** Mar. 22, 2022**

- (54) **TOILET PAPER STAND** 6,988,691 B1 * 1/2006 Lai A47K 10/38
242/594
- (71) Applicant: **Umbra LLC**, Buffalo, NY (US) D533,750 S * 12/2006 Goodman A47K 10/38
D7/601
- (72) Inventor: **Nathan Asis**, Richmond Hill (CA) D546,583 S * 7/2007 Snell A47K 10/38
D6/677.5
- (73) Assignee: **UMBRA LLC**, Buffalo, NY (US) D694,069 S * 11/2013 Goodman D7/601
D753,941 S * 4/2016 Boen D6/681.1
D766,046 S * 9/2016 Guindi D7/601
- (**) Term: **15 Years** 2012/0234963 A1 * 9/2012 Channel A47K 10/38
242/560.2

(21) Appl. No.: **35/001,951**

* cited by examiner

(22) Filed: **Oct. 20, 2020**

Primary Examiner — Mary Ann Calabrese

(80) **Hague Agreement Data**

(74) *Attorney, Agent, or Firm* — Simpson & Simpson, PLLC

Int. Filing Date: **Oct. 20, 2020**

Int. Reg. No.: **DM/212095**

Int. Reg. Date: **Oct. 20, 2020**

Int. Reg. Pub. Date: **Jan. 15, 2021**

(51) **LOC (13) Cl.** **23-03**

(52) **U.S. Cl.**

USPC **D6/523**

(58) **Field of Classification Search**

USPC D6/512, 515, 518-521, 523, 524, 527,
D6/677.5, 682.1, 682.5

CPC A47K 10/00; A47K 10/16; A47K 10/22;
A47K 10/24; A47K 10/32; A47K 10/38

See application file for complete search history.

(56) **References Cited**

U.S. PATENT DOCUMENTS

- 6,405,973 B1 * 6/2002 Hollinger A47K 10/38
242/591
- D493,643 S * 8/2004 Snell D6/523

(57) **CLAIM**

The ornamental design for a toilet paper stand, as shown and described.

DESCRIPTION

- 1 Toilet paper stand
- 1.1 : Perspective
- 1.2 : Front
- 1.3 : Back
- 1.4 : Left
- 1.5 : Right
- 1.6 : Top
- 1.7 : Bottom

1 Claim, 7 Drawing Sheets

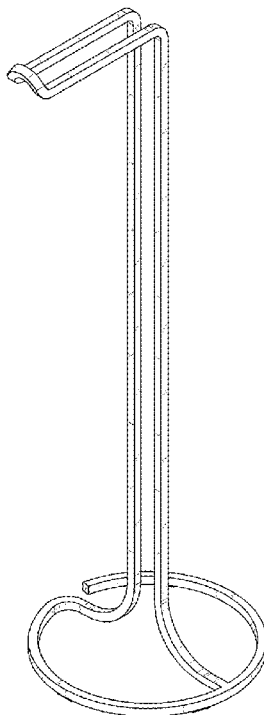

1.1

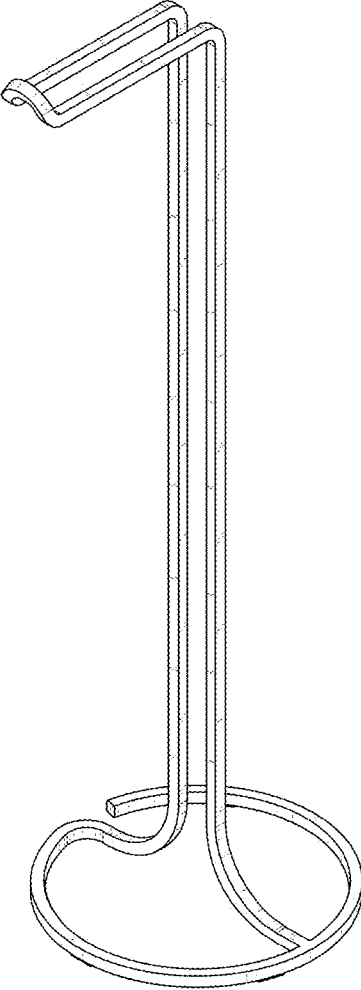

1.2

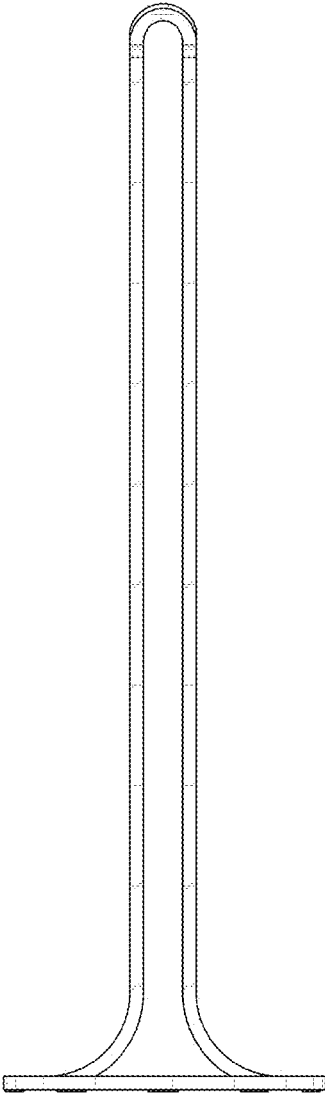

1.3

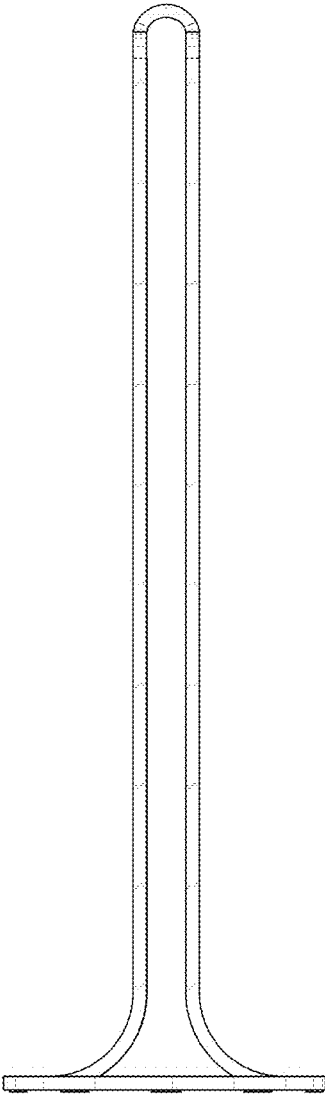

1.4

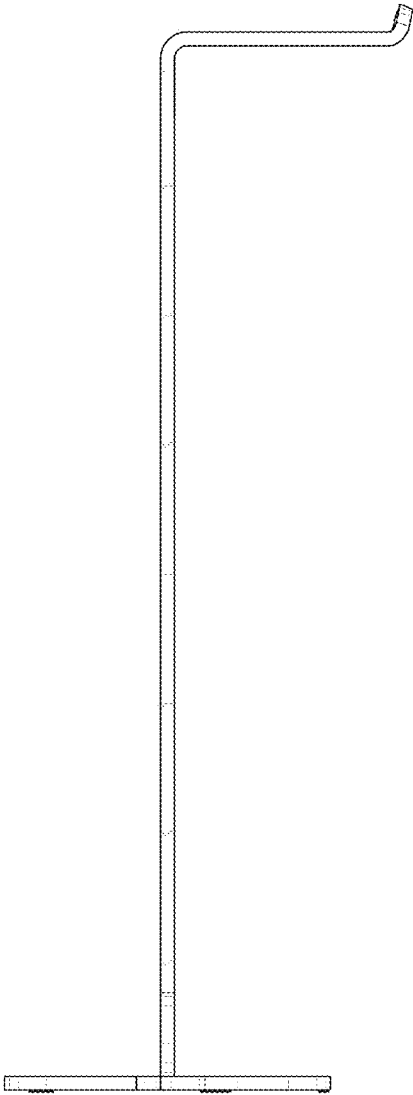

1.5

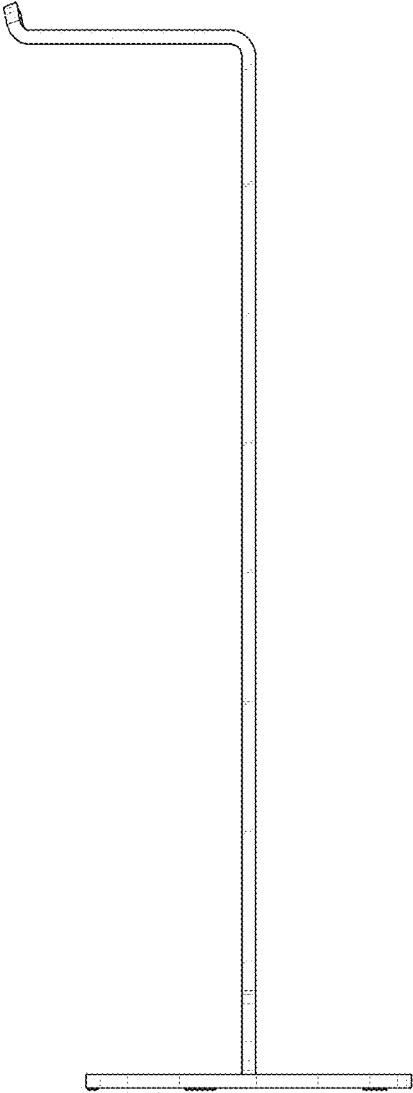

1.6

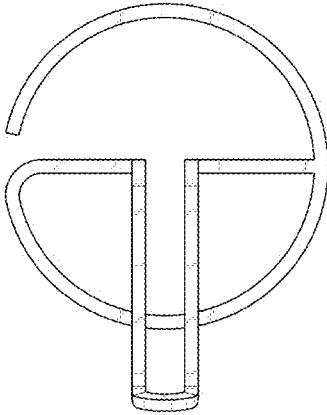

1.7

